

TOYOTA CAMRY

СПОЙЛЕР

Руководство к установке

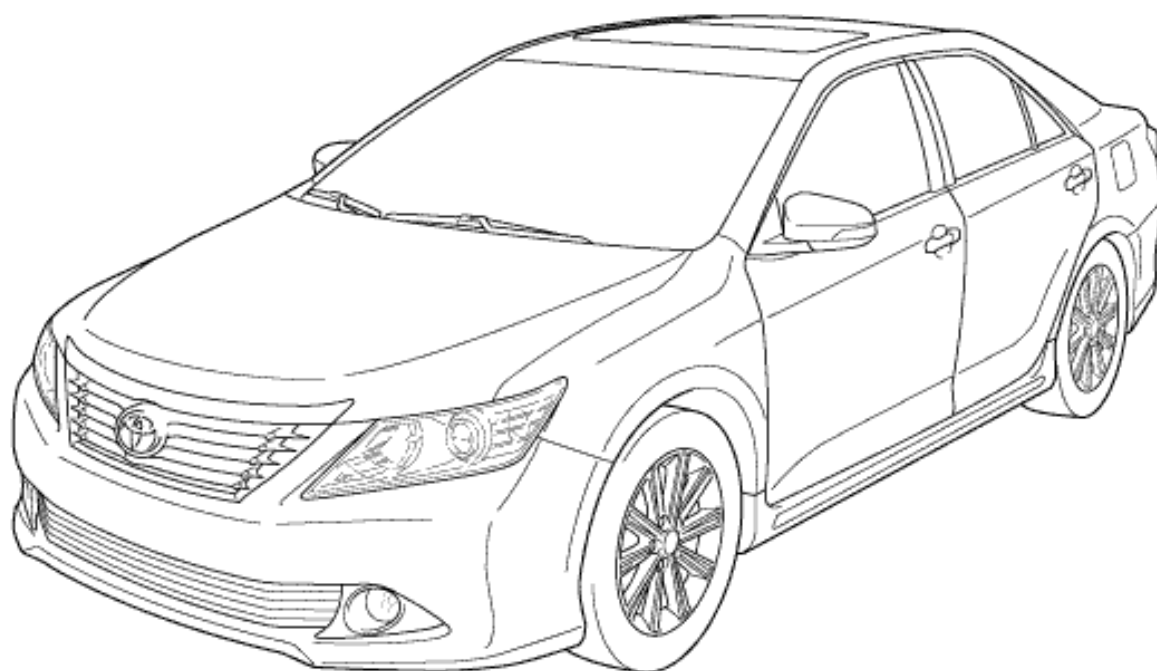

Модельный год: 2011

Модельный код: ACV51L-REP NKX, ASV50L-RET NKX, GSV50L-RET GKX





Каталожный номер: NLS4851S10





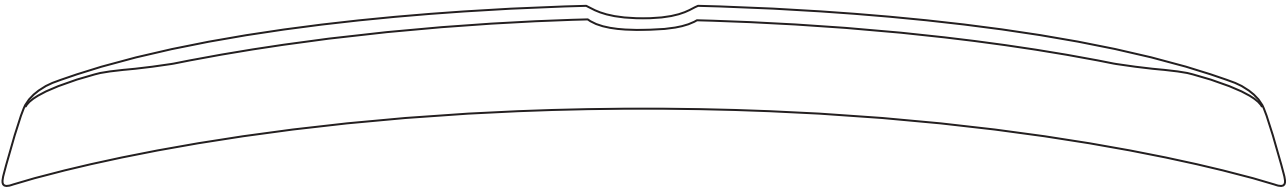
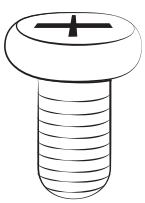
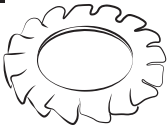

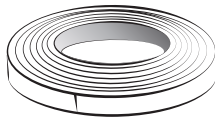
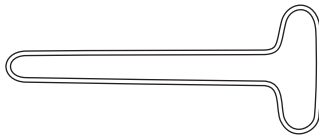

Вес: 1,9 кг

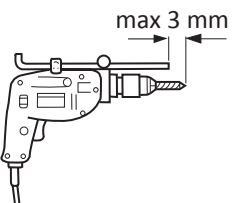
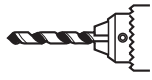
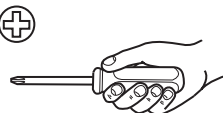
Время установки: 90 мин.

Издание №1 от 24.12.2013

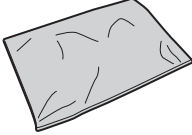
NLS4851S10

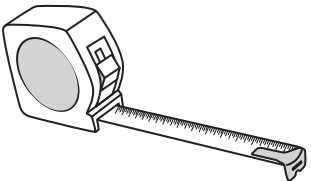
A  <p style="text-align: right;">1x</p>			
B  <p style="text-align: right;">3x</p>	C  <p style="text-align: right;">3x</p>	D  <p style="text-align: right;">2x</p>	E  <p style="text-align: right;">1x</p>
F  <p style="text-align: right;">1x</p>	G  <p style="text-align: right;">1x</p>	H  <p style="text-align: right;">1x</p>	

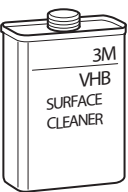
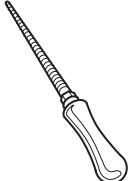
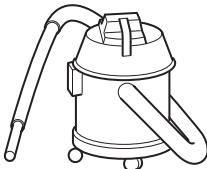
	 <p>Ø 3 mm Ø 7 mm</p>			
	 <p>PROTECTION</p>			
 				

TOYOTA CAMRY

Модельный год: 2011

Руководство по эксплуатации

2 из 9

СПОЙЛЕР

Каталожный номер: NLS4851S10

Издание №1 от 24.12.2013

1

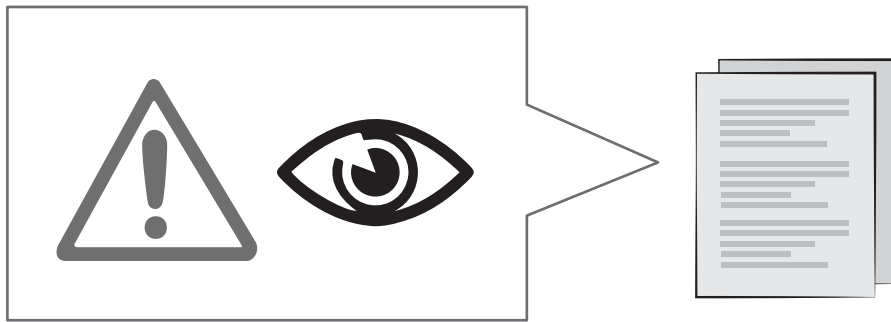

2

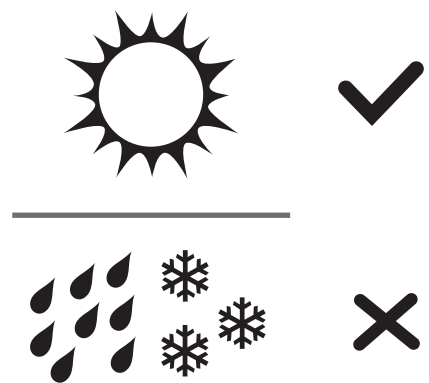
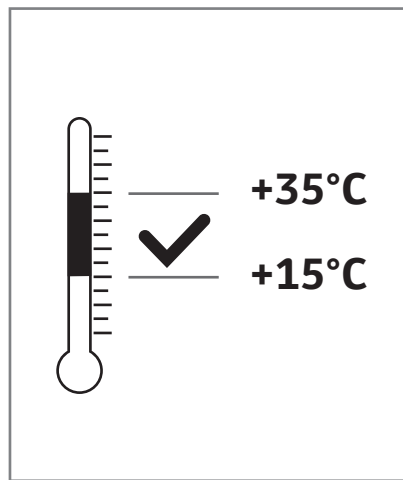

3

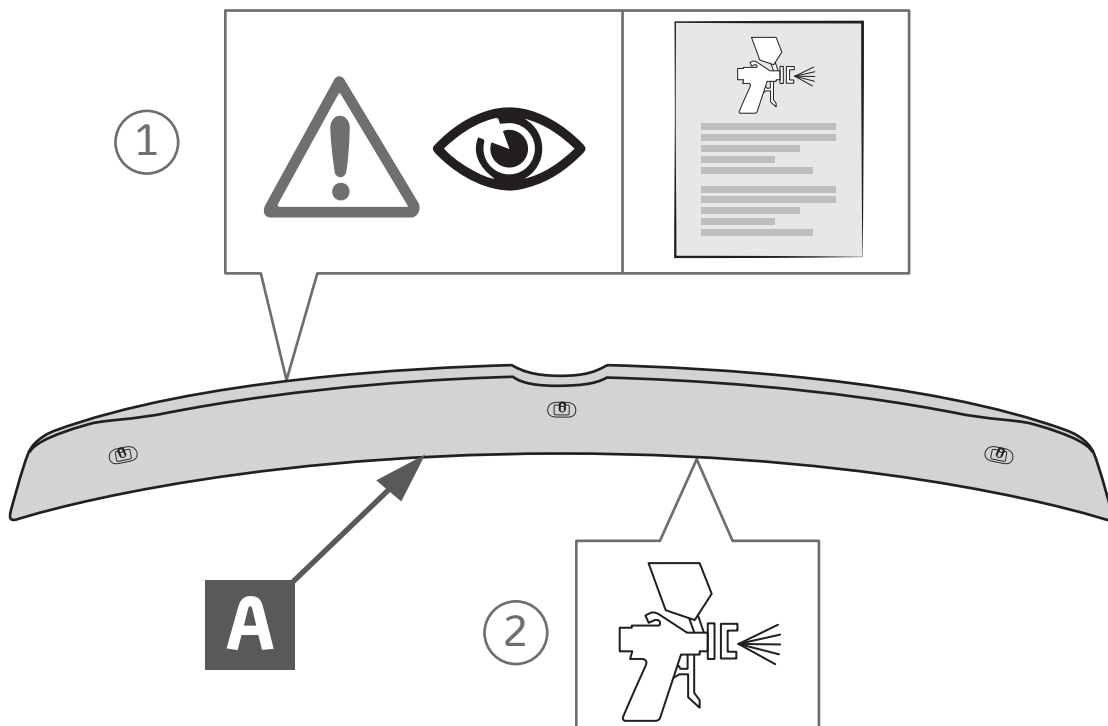

TOYOTA CAMRY

Модельный год: 2011
Руководство по эксплуатации

3 из 9

СПОЙЛЕР

Каталожный номер: NLS4851S10
Издание №1 от 24.12.2013

4

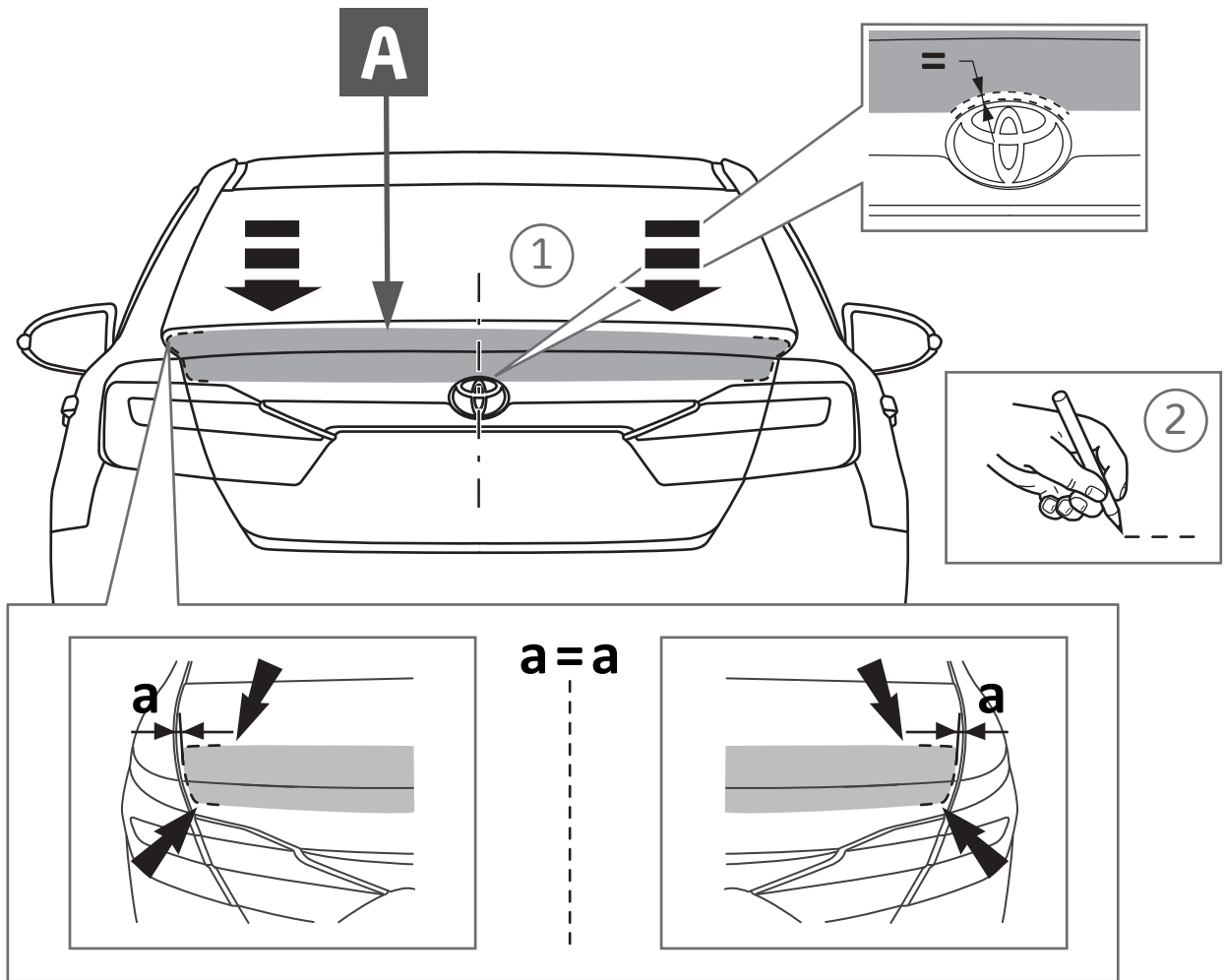

5

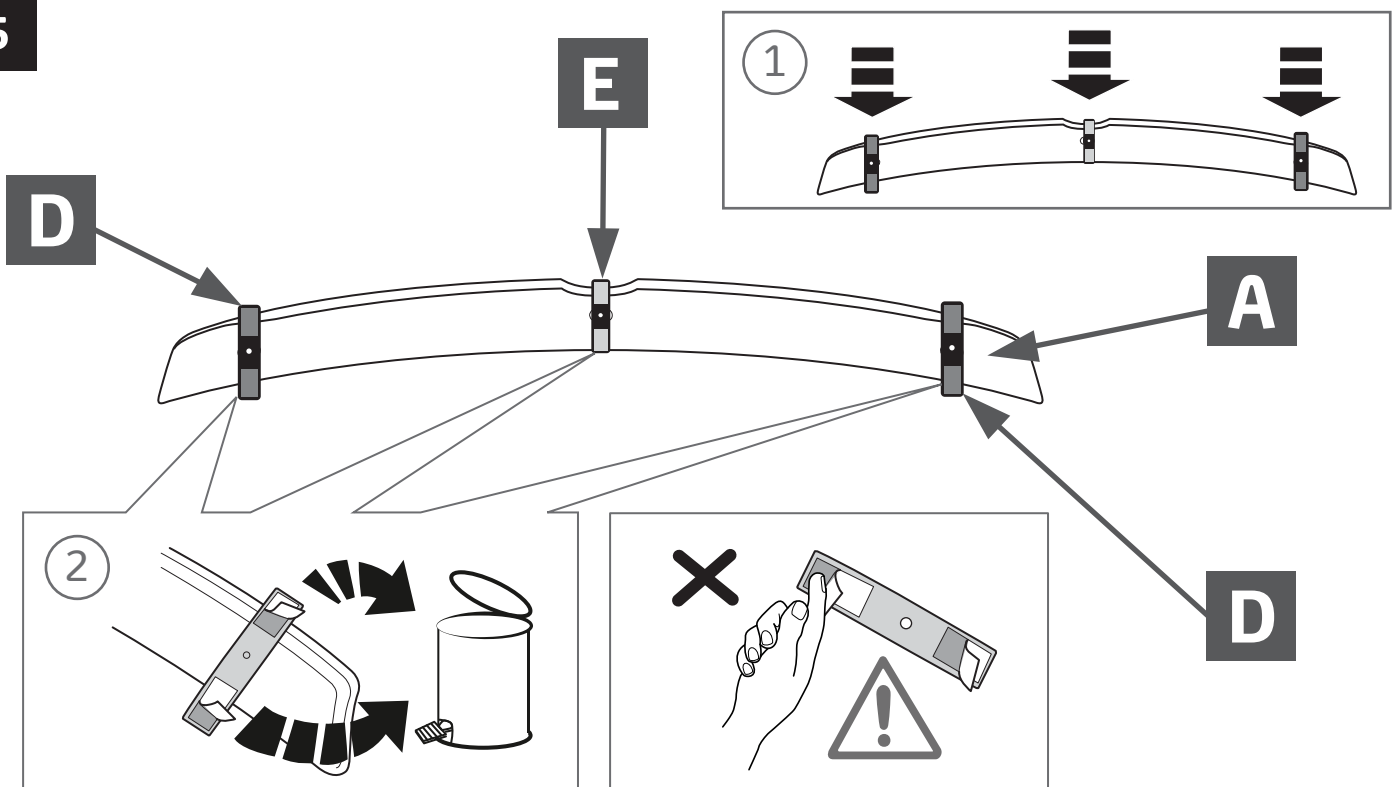

TOYOTA CAMRY

Модельный год: 2011
 Руководство по эксплуатации

4 из 9

СПОЙЛЕР

Каталожный номер: NLS4851S10
 Издание №1 от 24.12.2013

6

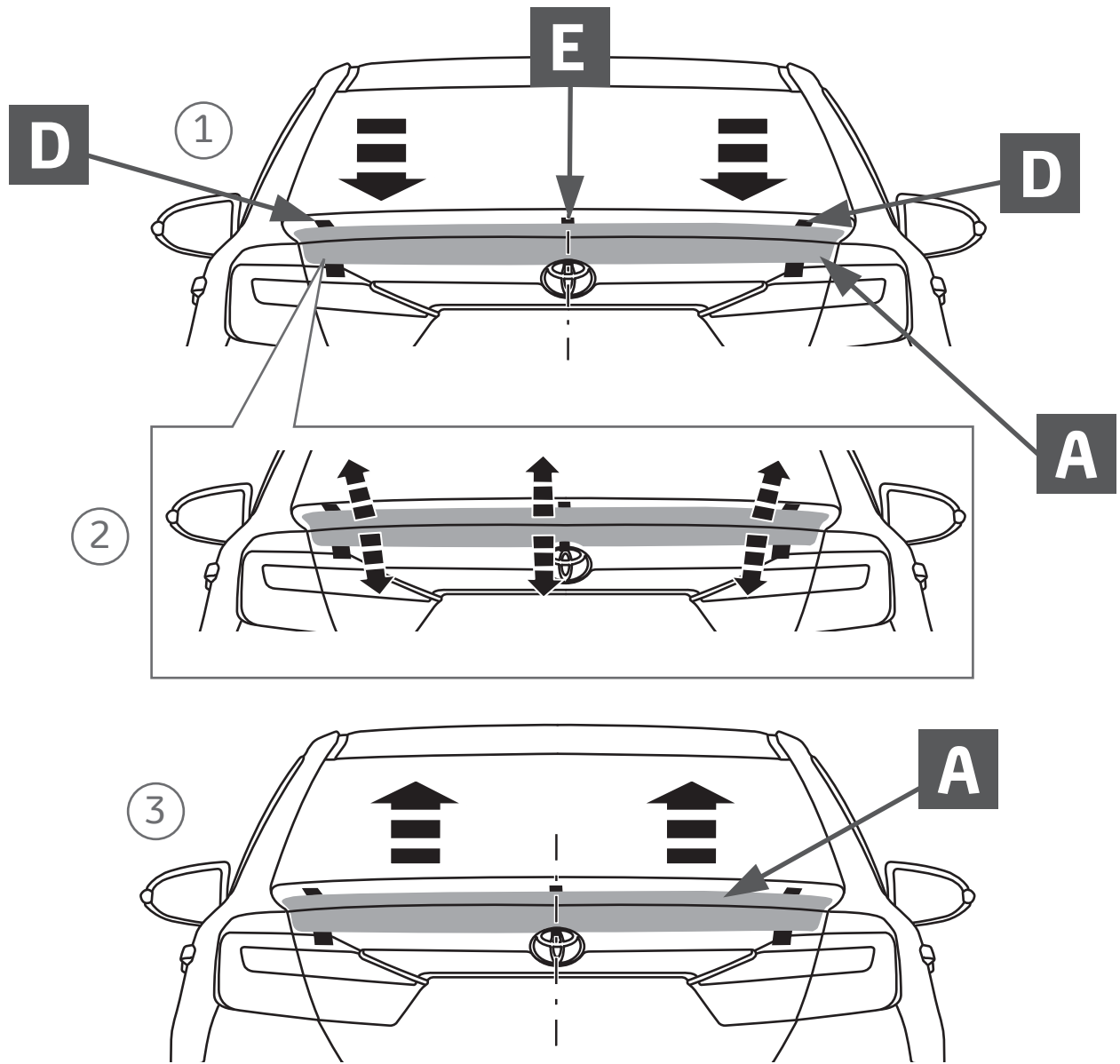

7

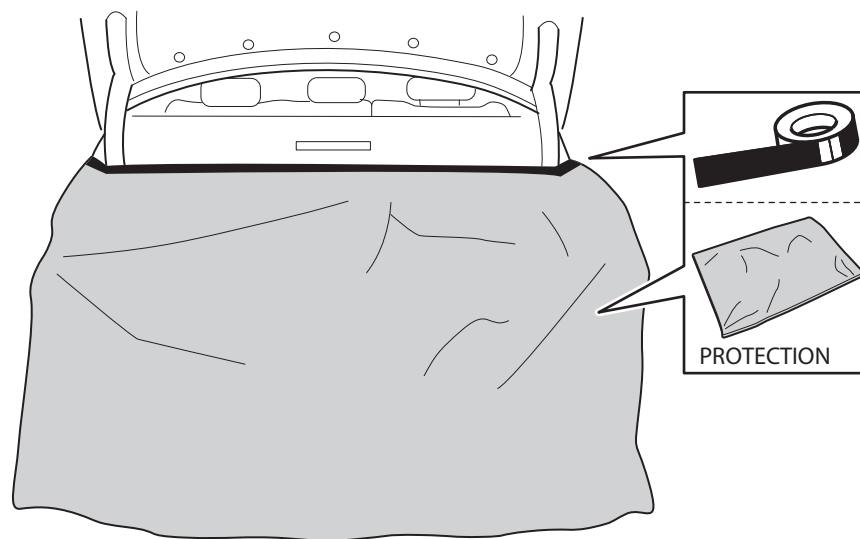

TOYOTA CAMRY

Модельный год: 2011

Руководство по эксплуатации

5 из 9

СПОЙЛЕР

Каталожный номер: NLS4851S10

Издание №1 от 24.12.2013

8

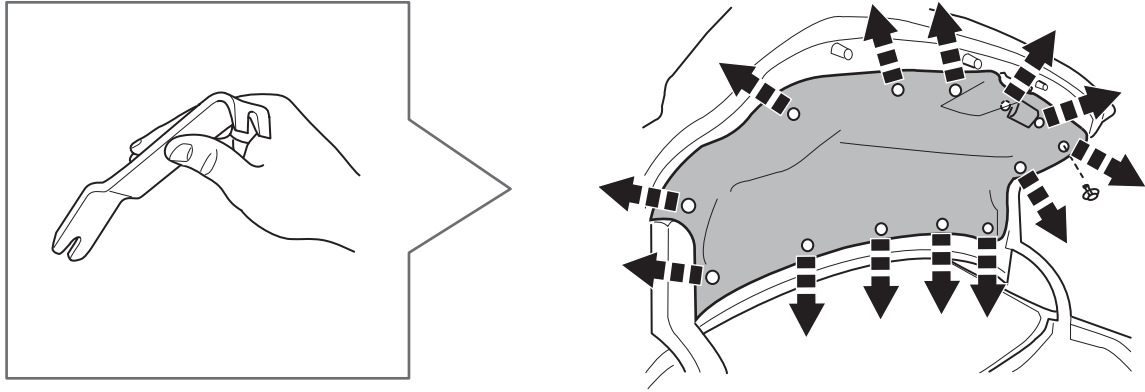

9

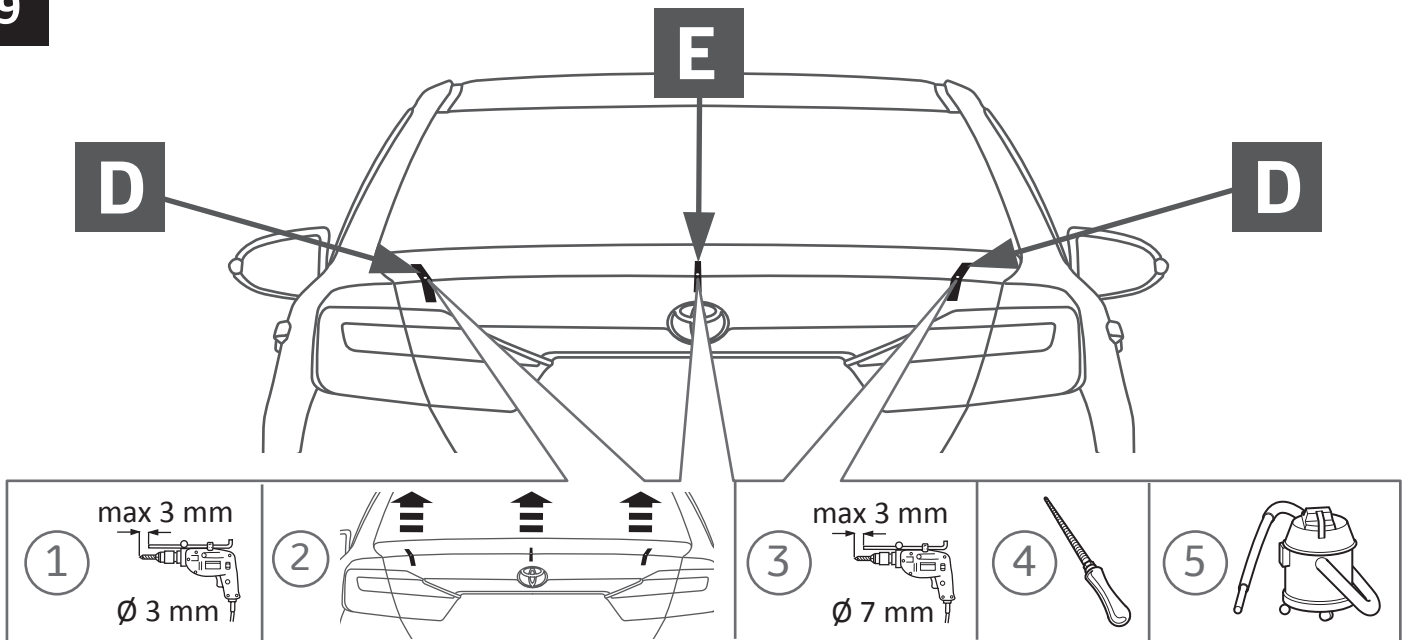

10

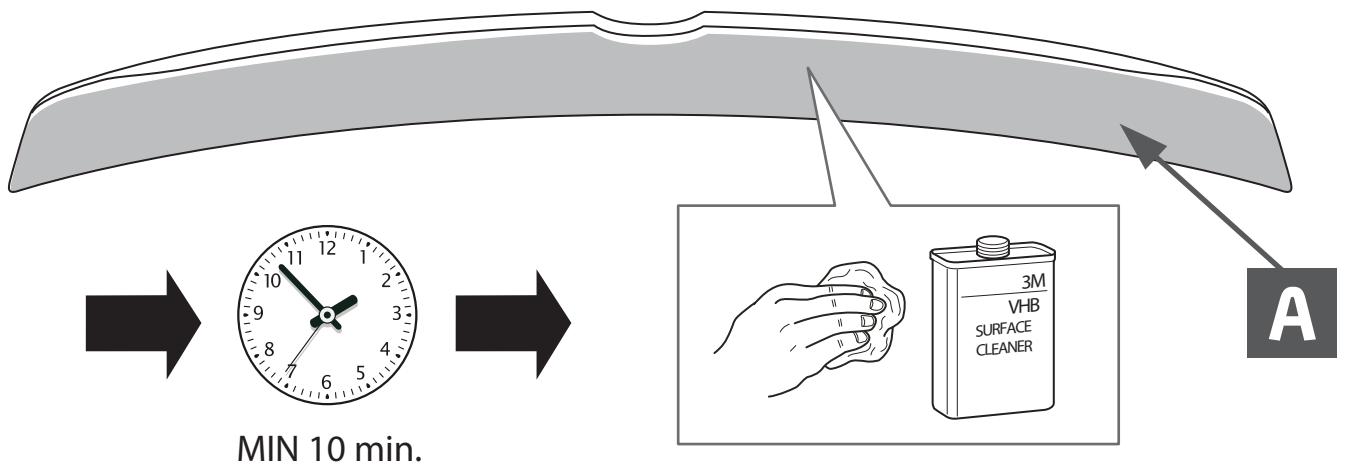

TOYOTA CAMRY

Модельный год: 2011
Руководство по эксплуатации

СПОЙЛЕР

Каталожный номер: NLS4851S10
Издание №1 от 24.12.2013

11

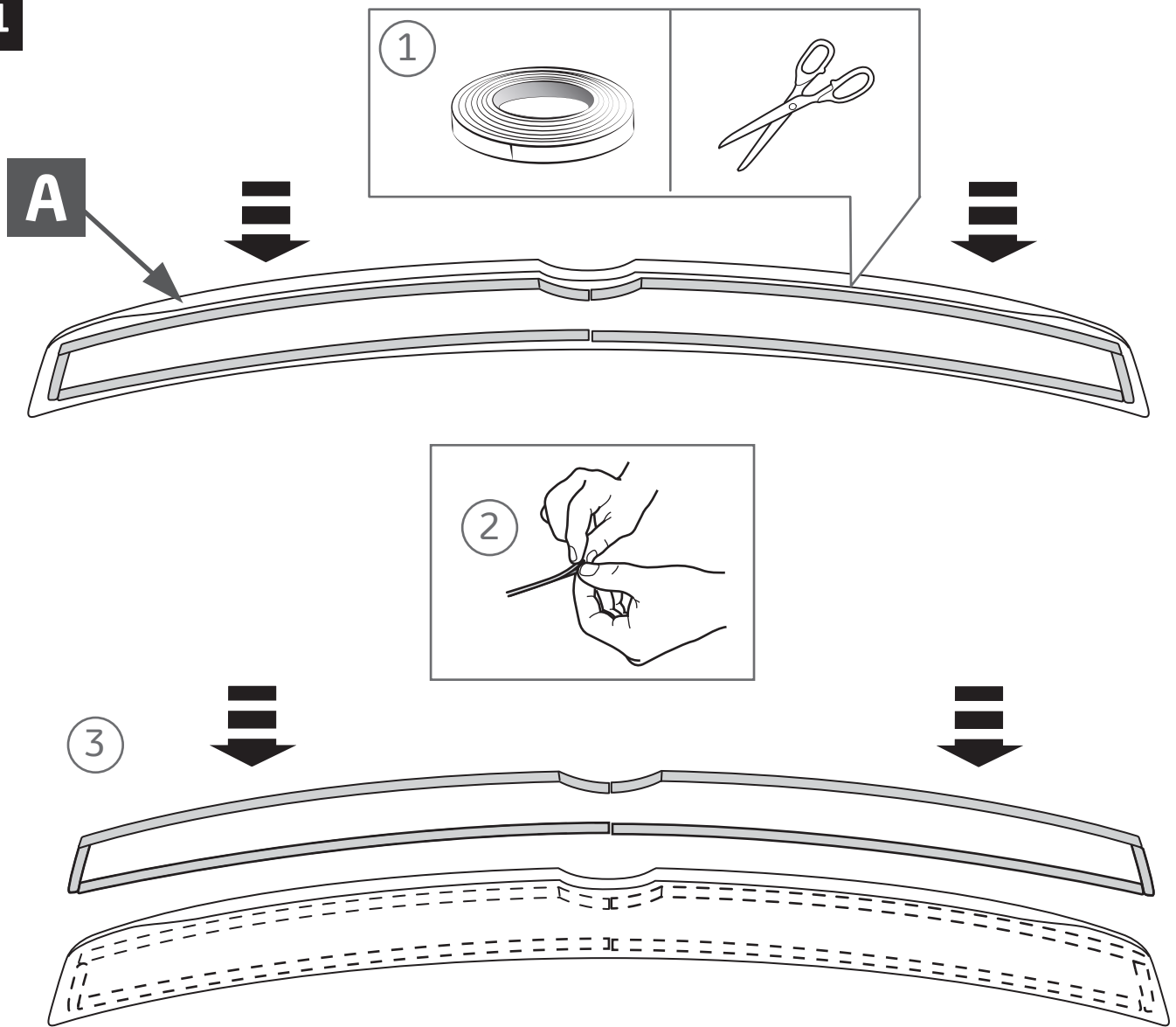

12

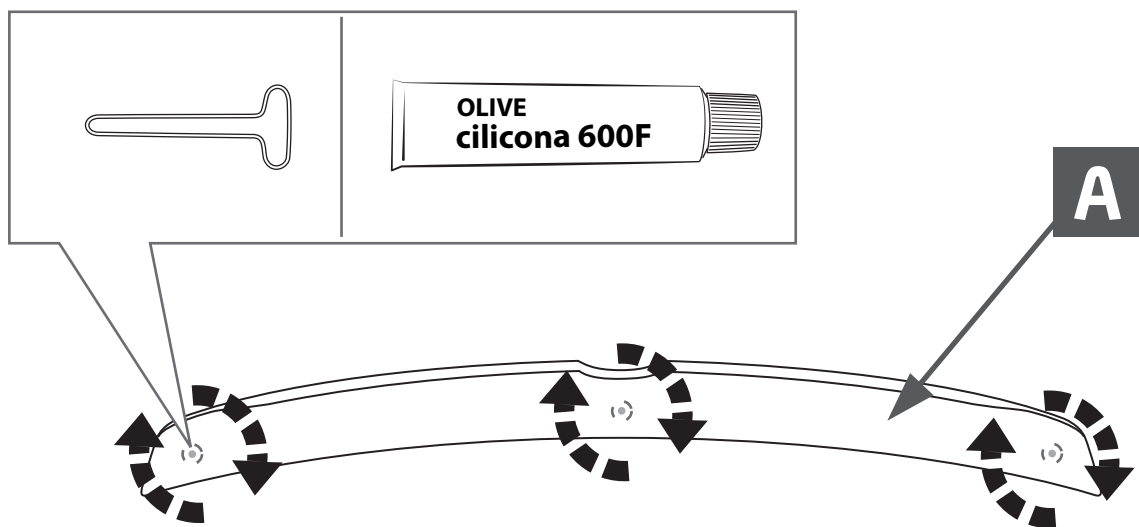

TOYOTA CAMRY

Модельный год: 2011

Руководство по эксплуатации

7 из 9

СПОЙЛЕР

Каталожный номер: NLS4851S10

Издание №1 от 24.12.2013

13

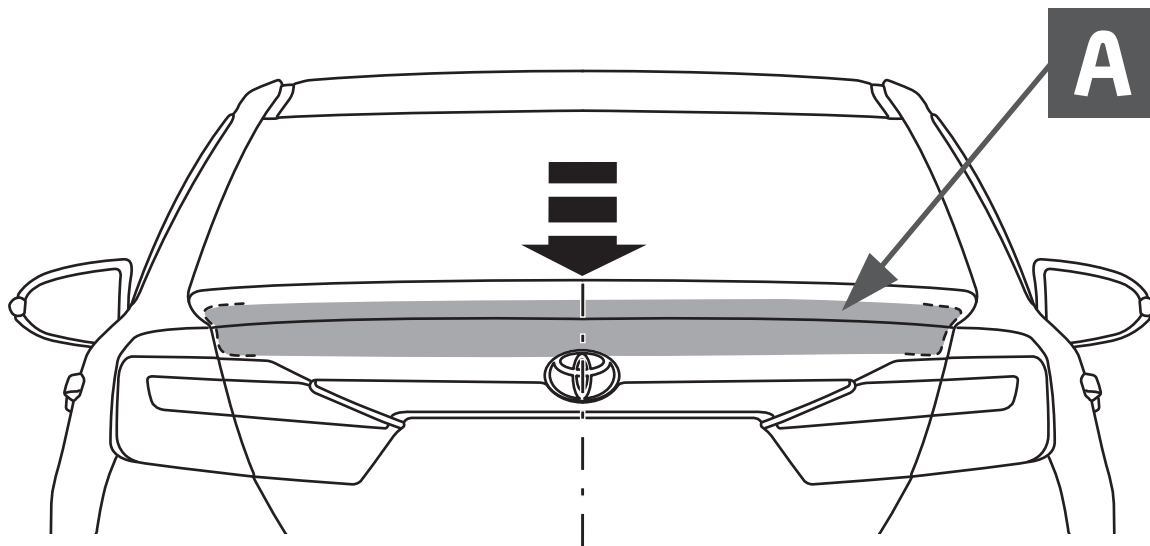

14

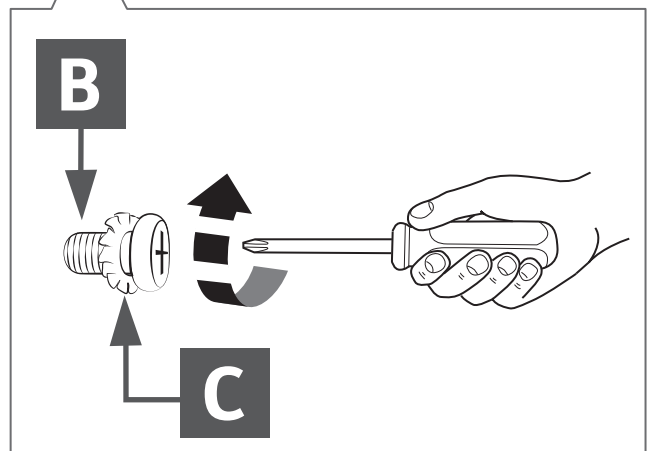
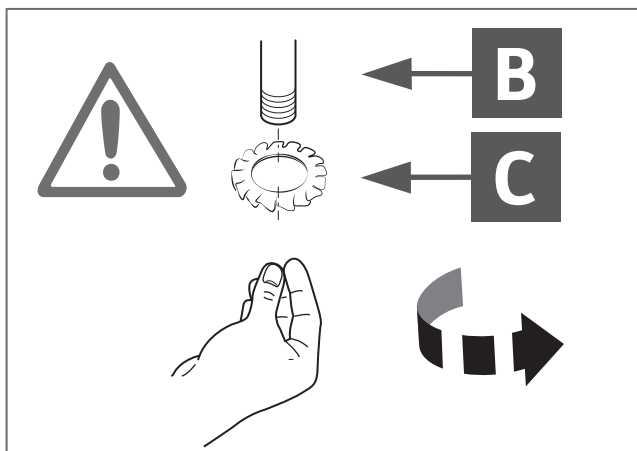
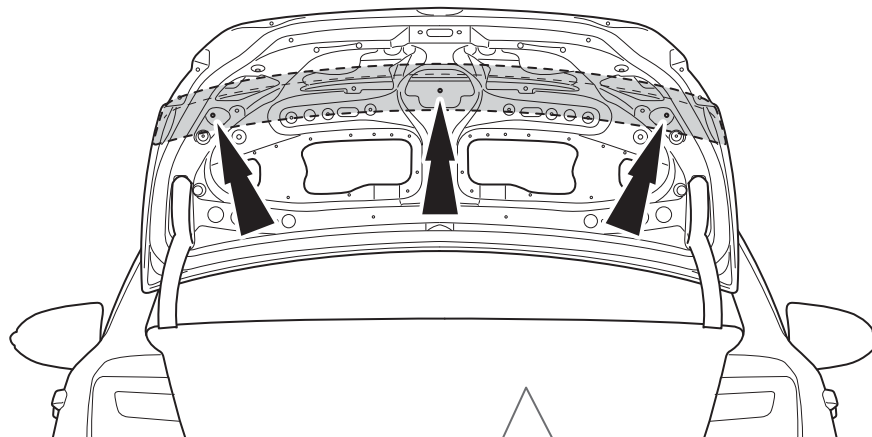

TOYOTA CAMRY

Модельный год: 2011

Руководство по эксплуатации

8 из 9

СПОЙЛЕР

Каталожный номер: NLS4851S10

Издание №1 от 24.12.2013

15

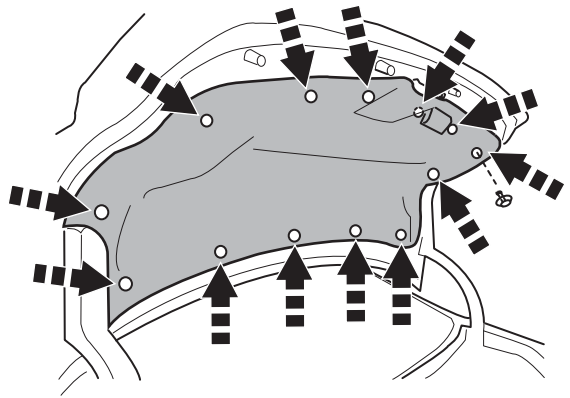
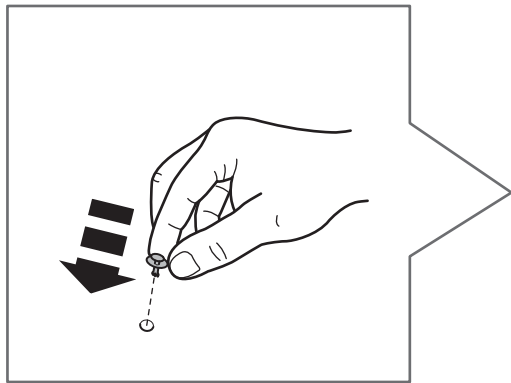

16

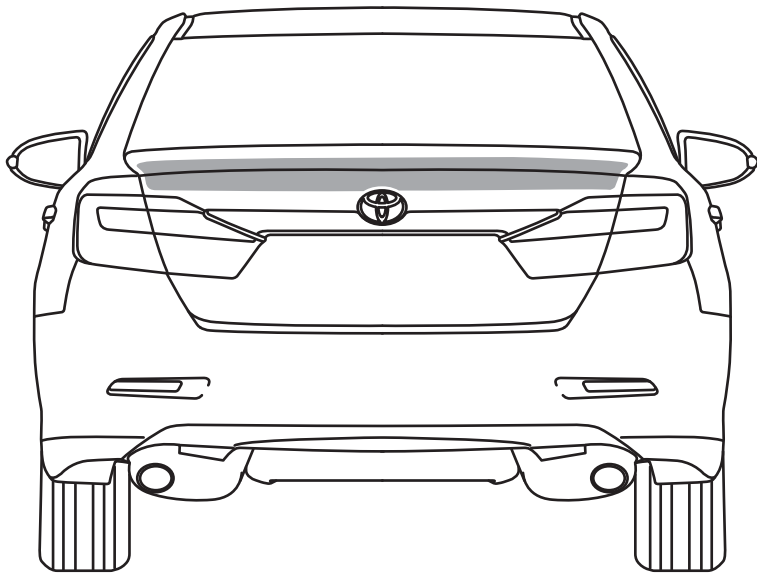

Max 100 Km/hr

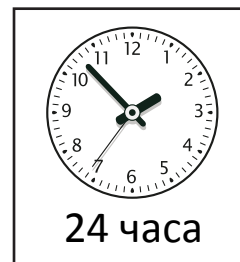
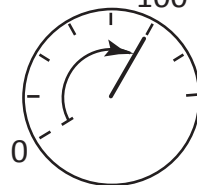

24 часа

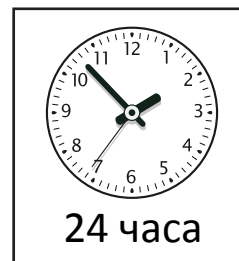
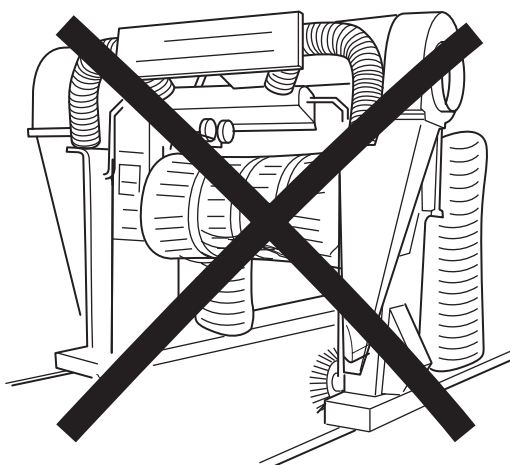

24 часа

TOYOTA CAMRY

Модельный год: 2011

Руководство по эксплуатации

9 из 9

СПОЙЛЕР

Каталожный номер: NLS4851S10

Издание №1 от 24.12.2013